



# INSTALLATION AND USER MANUAL

**ECOFLEX TD**

**EF02TD**







1. INTRODUCTION .....	1
2. GENERAL INDICATIONS .....	1
3. TECHNICAL INFORMATION .....	3
4. INSTALLATION STEPS .....	5
5. THERMODYNAMIC SOLAR PANEL INSTALLATION .....	6
6. PLACING ECOFLEX TD .....	8
7. CONNECTION BETWEEN ECOFLEX TD AND PANEL .....	10
8. HYDRAULIC CONNECTION .....	11
9. ELECTRICAL CONNECTION .....	13
10. COMMISSIONING. CONTROLLER .....	14
11. WARRANTY CONDITIONS .....	24



## 1. INTRODUCTION

Thank you for buying a product manufactured by CLIMER TECHNOLOGY. This product has been manufactured according to the European Quality Standards, incorporates prime grade materials and its correct working has been tested before it leaves our facilities.

Through this Installation and User Manual, you will be guide towards the correct and safety installation of the product. It is necessary to carefully read this manual before making any handling to avoid problems arising from the misuse of the product.

The company CLIMER TECHNOLOGY reserves the right to modify the information included in this document at any time without prior notice.

## 2. GENERAL INDICATIONS

### 2.1. Safety notes

The incorrect or inappropriate use of this product could lead to hazardous situations, causing damage or injuries to the user, third parties or even to the product itself or material goods.

- The installer has the responsibility to install the minimum safety devices (hydraulic and electrical) set out in this Manual. In case of failure, the lack of any device may cause burns or other injuries.
- The installer has the responsibility to inform the user about the function and placement of the safety devices installed into the device and the installation.
- The water outlet temperature could reach 62 degrees. Do not touch the pipes while the system is working to avoid any risk of burns.

### 2.2. Qualification of the installer

Since the installation of the ECOFLEX TD involves handling coolant as well as carry out welding work, it is needed the technical staff have the official certification that accredits them as authorized to handle coolants.

The installer must explain the user the application of the product and the use and management of the unit, and he should provide the user all the documentation supplied with the equipment.



### **2.3. Package contents**

The ECOFLEX system comprises the following components:

- EF02TD unit
- Thermodynamic panel
- Anchoring elements
- User Manual

### **2.4. Indications about transport and unpacking the unit**

The unit is supplied packed into a wooden pallet properly secured to prevent damage during transport.

*The material that CLIMER TECHNOLOGY uses to the packing are recyclables, so dispose it in an appropriate container.*

Use a forklift or hand pallet truck to transport the unit to the installation site, always introducing the forks into the bottom of the pallet being careful not to damage the unit.

In case you identify any damage at the time of the reception of the unit, it is mandatory to register it in the reception note of the transport company, and then, submit the complaint.

For this reason, it is recommended to make a thorough visual inspection of the goods before signing the reception note.



### 3. TECHNICAL INFORMATION

#### 3.1. Operating Principle

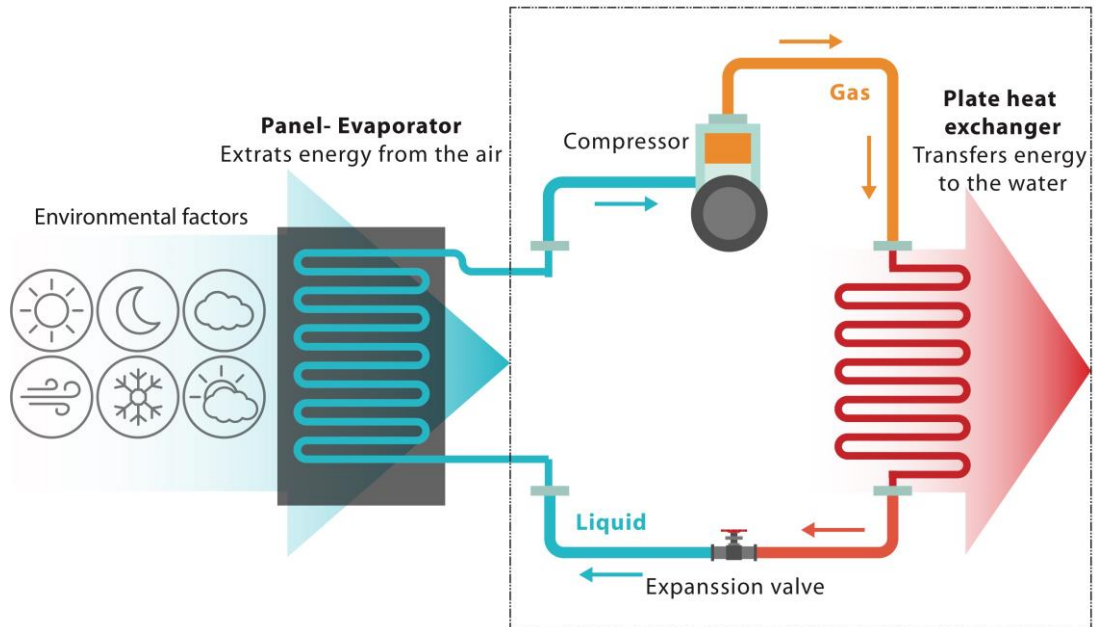

Figure 1. Operating principle

#### 3.2. Dimension drawings

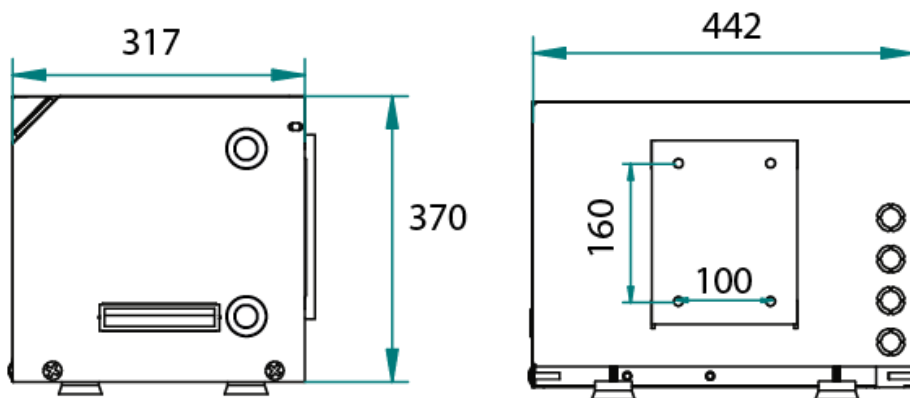

Figure 2. Dimensions

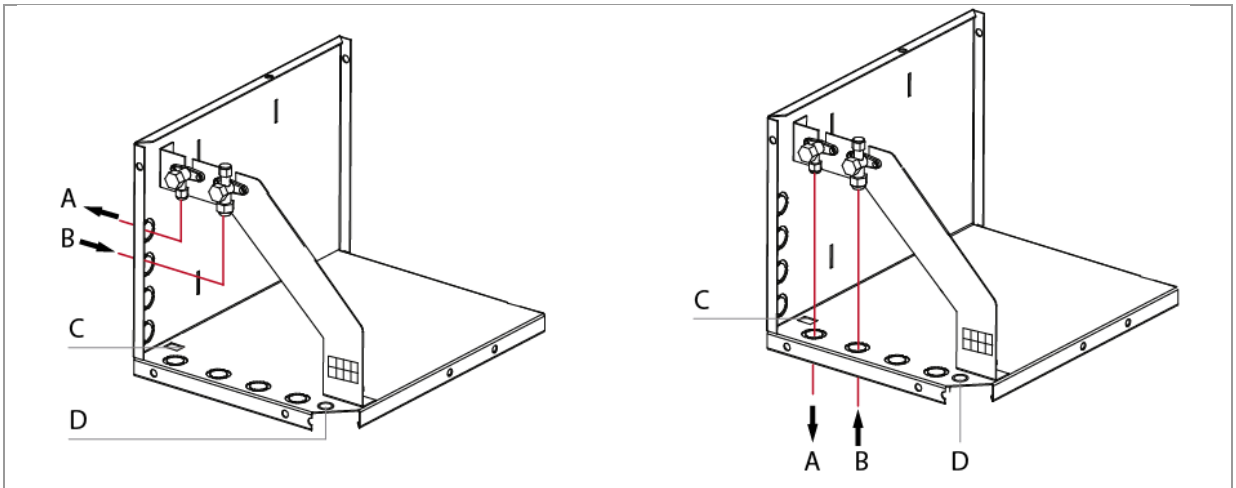

Figure 3. Connections (removing the cover)

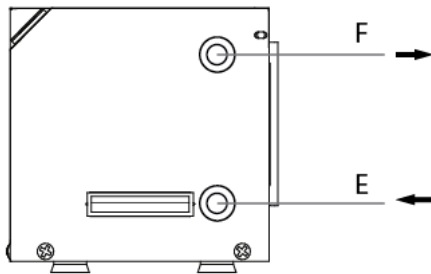

Figure 4. Side connections

**A:** Refrigerant outlet (1/4")

**B:** Refrigerant inlet (3/8")

**C:** Power supply

**D:** Temperature probe / Pump connection

**E:** Cold water inlet, 3/4"

**F:** Hot water outlet, 3/4"



### 3.3. Technical data

Model	EF02TD
<b>Heat pump data</b>	
Heating capacity range (1), W	1430 – 2560
Input power range (1), W	450 – 540
Energy Efficiency Class	A
Load profile	L
Maximum temp. HP, °C	55
Refrigerant / Charge, kg	R134A / 1.0
Minimum water flow, L/h	250
Pressure drop (heat exchanger), kPa	2
Water inlet/outlet, inch	3/4
<b>Electric data</b>	
Power supply, V/ph/Hz	230/1/50
Maximum power absorbed, W	600
<b>Thermodynamic panel</b>	
Number of panels	1
Dimensions, mm	1700 x 800
Maximum operating pressure, bar	10
Refrigerant inlet/outlet, inch	1/4 · 3/8

(1) Conditioned by solar radiation and outside temperature

## 4. INSTALLATION STEPS

Before starting the installation, check the availability of all the necessary components and tools:

- High- and low-pressure manometers
- Vacuum pump
- Scales
- Nitrogen bottle
- Refrigerant quality copper pipe
- Pipe-cutter
- Tube bender
- Pipe expander
- Welder
- Copper Rods (40% Silver)
- Insulating hose
- Drill
- Screwdriver





- Hydraulic installation components
- Electric installation components

Once it has been checked that it is available all the necessary components and tools, the installer should follow the next steps:

1. Placing and anchoring panel
2. Joining and welding the refrigerant pipes
3. Placing the ECOFLEX TD
4. Joining and welding liquid and suction line between ECOFLEX TD and panel
5. Nitrogen pressure test (maximum 10 bar)
6. Vacuum
7. Filling refrigerant installation
8. Hydraulic installation
9. Electric installation
10. Commissioning
11. Adjustment of refrigerant load

## **5. THERMODYNAMIC SOLAR PANEL INSTALLATION**

### **5.1. Site selection**

The choice of the installation site of the thermodynamic panel is a key factor in the final performance of the unit. For this reason, we recommend following the indications to achieve the best performance:

- South orientation is indeed the best to take the maximum advantage of solar radiation. Panel may also have other orientations, but northerly orientation is the worst to receive solar radiation.
- Inclination: The minimum inclination of the panel is 15° in order to ensure the correct evaporation of the coolant. It is recommended to install the panel with an inclination between 45° and 90°.



- Orientation: It is possible to install the panel both in vertical and horizontal position

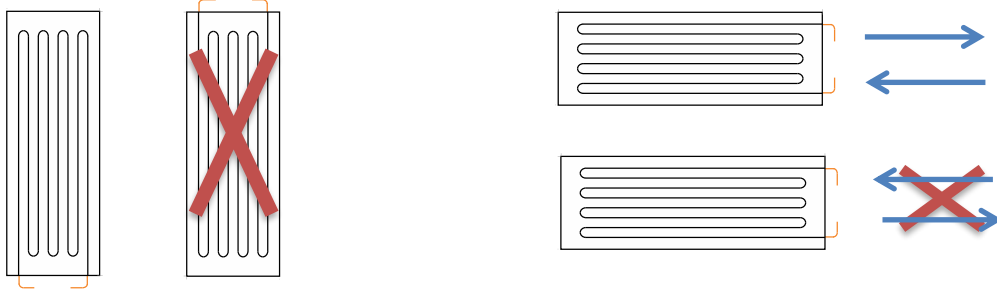

When the panel is installed in vertical position, the inlet and outlet connection shall be always at the bottom. (It is not allowed to install the reverse)

If the panel is installed at horizontal position, refrigerant inlet pipe should be connected into the bottom connection.

- Distances to ECOFLEX TD:

The maximum allowed distance from the panel to the ECOFLEX TD is 12 meters.

In the picture below is shown the dimensions of the panel:

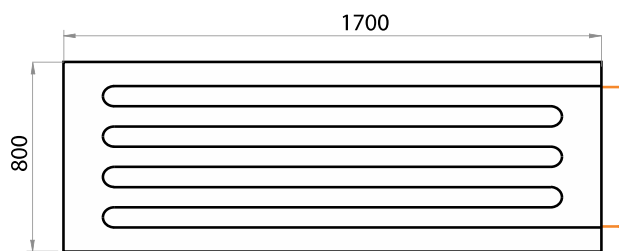

Figure 5. Side connections

## 5.2. Anchoring panel

Beside the panel, it is supplied a bag with anchoring elements that contains the following pieces:

- 6 x Aluminium support (L shape)
- 6 x Screws M5
- 12 x Nuts M5



- 18 x Washer 5
- 18 x Sheet Metal Screws
- 18 x Blocks M6

Anchor the panel using the lateral and front holes to the suitable surface.

## 6. PLACING ECOFLEX TD

The place where the system will be installed should allow an easy access to make maintenance work or inspection.

Beside these factors, it is important to consider the following indications regards the installation site:

- The system has been designed and manufactured for it indoors utilization. In case the system has to be placed outdoors, it must be protected against the adverse weather conditions (direct solar radiation, rain, snow...)
- Try to place ECOFLEX TD as near as possible to the panel installation and the buffer tank.

The equipment allows the installation on floor or on wall.

- Wall mounted: Ensure that the surface can support the total weight of the device. The installer must fix the bracket to the wall and the insert the tabs into the corresponding slot of the back of the unit.

**NOTE: It is recommended to install Silent blocks to avoid the transmission of vibration to the wall.**

- Floor mounted: Screw 4 leg into the holes of the bottom.

**NOTE: It is recommended to install Silent blocks to avoid the transmission of vibration to the floor.**

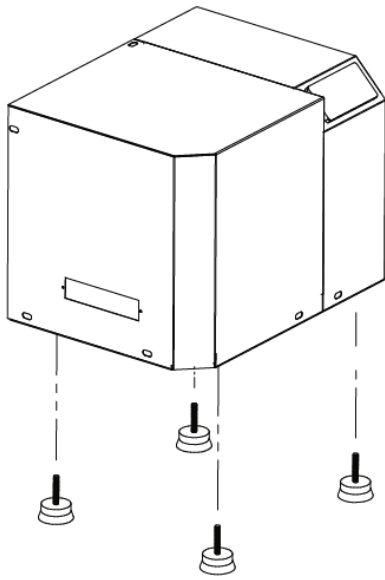

Figure 6. Floor standing

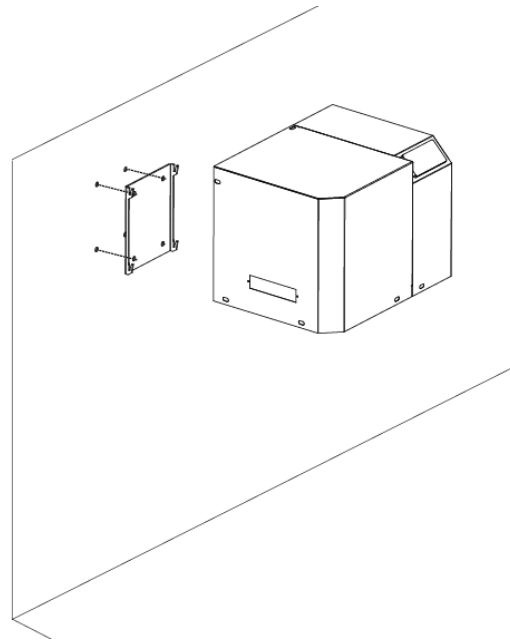

Figure 7. Wall mounted

If the equipment is to be installed in the wall, be aware that a minimum distance between the water outlet of the tank and the outlet of ECOFLEX TD must be observed to ensure a good functioning of the pump and the equipment.

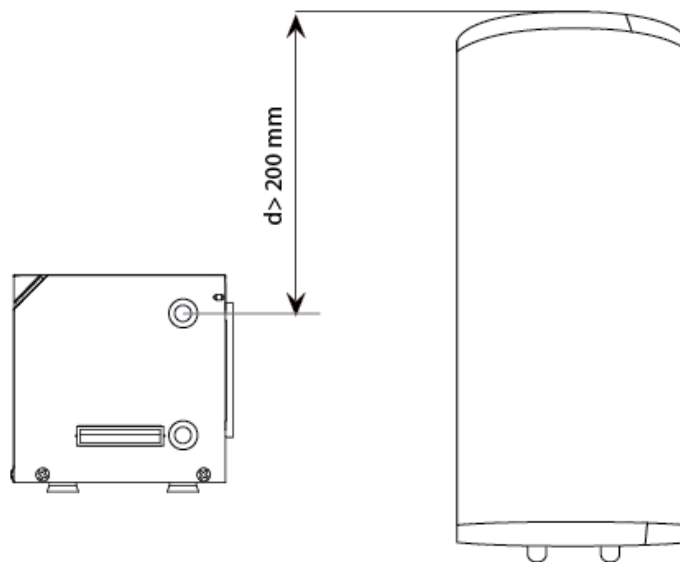

Figure 8. Minimum distance from ECOFLEX to the water outlet of the buffer tank.



## 7. CONNECTION BETWEEN ECOFLEX TD AND PANEL

### a. Join refrigerant pipes

Panels are supplied with two nuts for the inlet and outlet connection. The inlet to each panel is 1/4 inch diameter. The installer has to insert the nut into the copper pipe, flare the pipe and then use the nut to fit it.

Repeat the procedure with the outlet connection using 3/8 inch copper pipe.

Then, join the suction line that comes from the panel to the coolant inlet of ECOFLEX TD, and the liquid line to the coolant outlet. The connections are threaded, if welding is needed, weld by oxyacetylene welding.

***IMPORTANT (Only when welding is needed):***

*It is recommended to weld pipelines by oxyacetylene welding.*

*Welding is a critical step in the installation and to do it well ensures that the system will run properly along its useful life.*

*Only expert staff should make this step by using proper tools and high-quality materials.*

### b. Nitrogen test and cleaning procedure

To check the tightness, introduce nitrogen by using the pressure gauge already installed into load ports.

**CAUTION: Never exceed a nitrogen load greater than 10 bars.**

Use leaking detector fluid at every welding and even in panel's connections to verify the absence of leaks.

### c. Vacuum

Connect the vacuum pipe to the pressure gauge to carry out a vacuum of the whole installation.

### d. Coolant filling

Open the load ports to fill the circuit with the refrigerant loaded into the system.



## 8. HYDRAULIC CONNECTION

The hydraulic connection depends on the existing buffer tank, if some type of connection for the recirculation or coil is available.

The possible connections are detailed as follows:

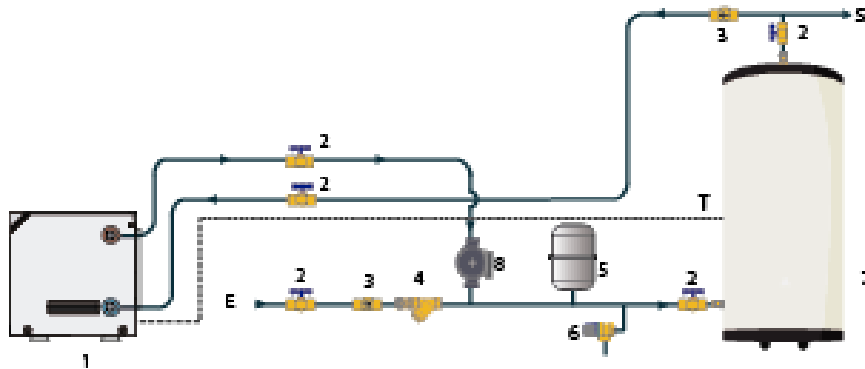

Figure 9. ECOFLEX TD connection on storage tank with two outlets

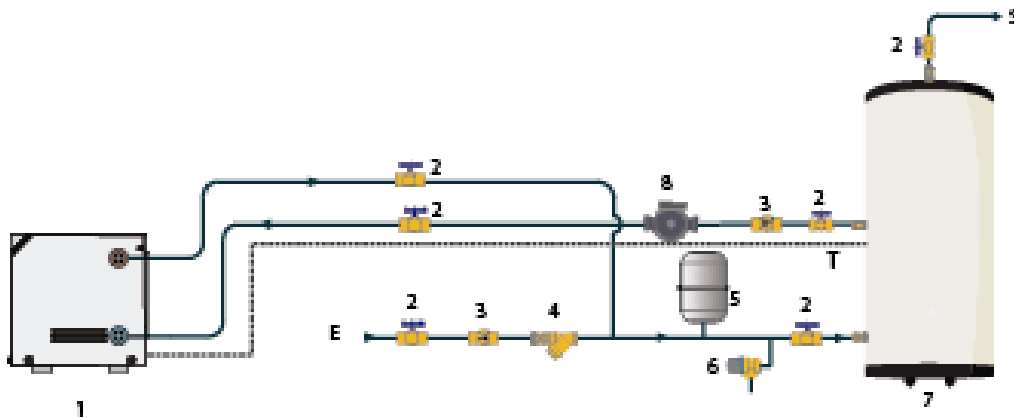

Figure 10. ECOFLEX TD connection on storage tank with a recirculation outlet

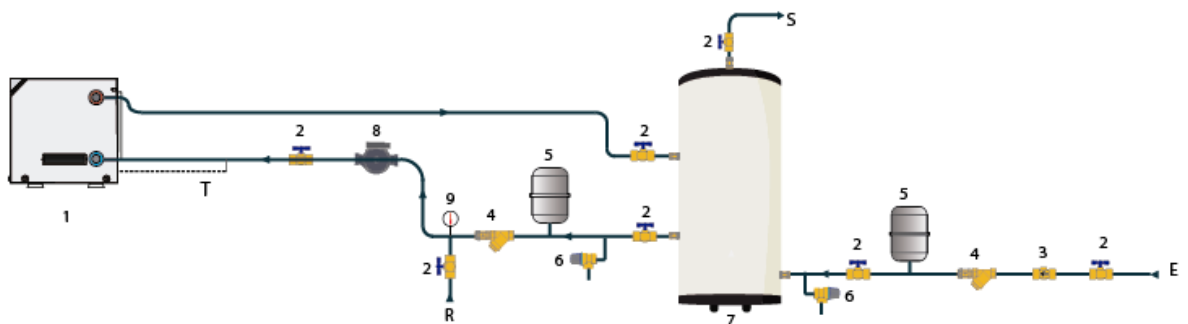

Figure 11. ECOFLEX TD connection, buffer tank with inner coil



The installer must install the following components of the hydraulic circuit:

- ECOFLEX TD (1)
- Gate valve (2)
- Check Valve (3)
- Inclined filter (4)
- Expansion vessel (5)
- Safety valve (6)
- Storage tank (7)
- Pump (8)
- Pressure gauge (9)
- Red water inlet (E)
- DHW output (S)
- Inlet water filled coil (R)
- Probe connection (T)

Once the hydraulic connections are made, purge the circuit to remove the air from the installation.

In addition, it is necessary to install electrolytic sleeves in the water connections to prevent galvanic corrosion in the pipes.

**IMPORTANT:**

- The water pipes must be at least 22 mm in diameter to avoid excessive losses in the circuit
- If the unit is to be installed on the wall, its height must not exceed half the storage tank.

**a. Pump connection**

For the choice of the pump, it is necessary to consider the pressure drop of the installed pipe as well as the accessories (elbows, filters, valves ...). See the technical data table for the water flow rate to be circulated through the equipment and the pressure drop of the installed heat exchanger.

**b. Temperature probe connection**

The equipment incorporates connected temperature probe. The installer must pass through the indicated opening (Figure 3, D) and connect it to the buffer tank. The position of the probe varies according to the type of buffer tank.

Follow the instructions in of the diagrams shown in Figures 9, 10 and 11.



## 9. ELECTRICAL CONNECTION

The power supply of the system is 230 V/1/50 Hz.

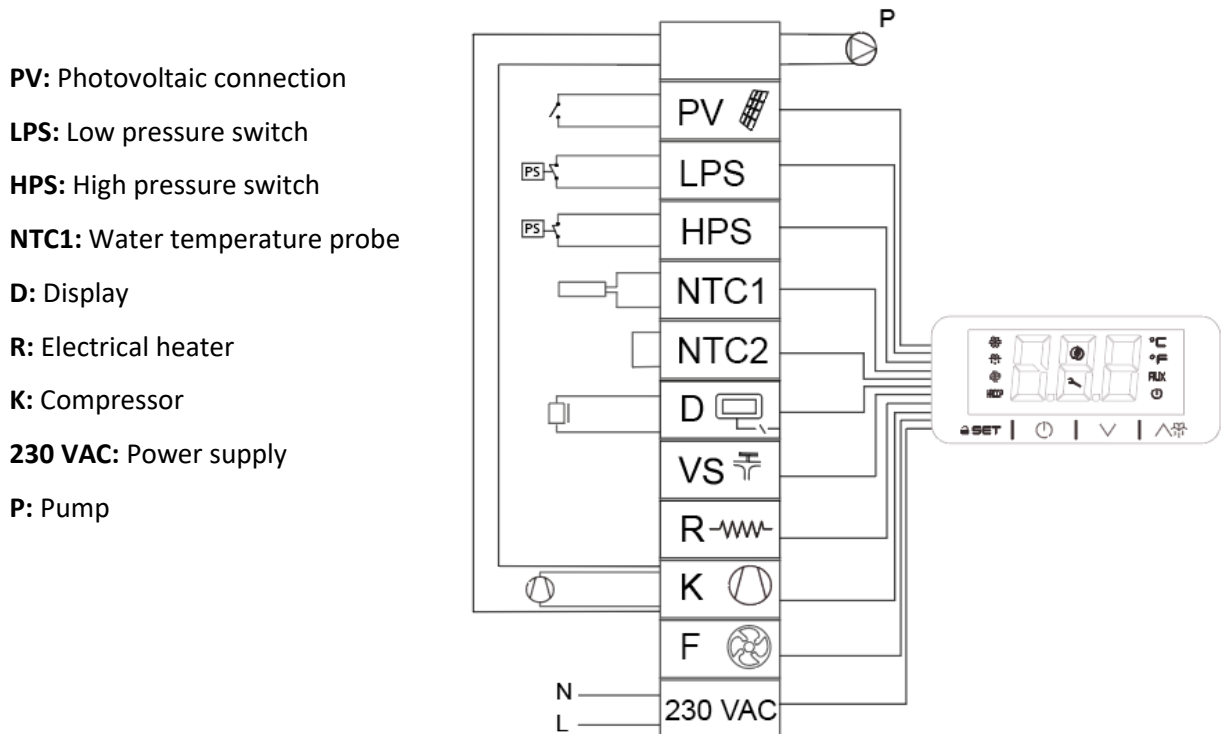

### 9.1. Pump

The installer must connect the electrical connection of the pump to the terminal block inside the ECOFLEX unit, as shown in the diagram above.

**IMPORTANT:** It is only permitted to connect a pump with a power supply of 230 V / 1 ph / 50 Hz and 3 A maximum current.

### 9.2. Electrical heater

It is possible to control the operation of an electrical heater installed inside the tank. To do this, the installer must connect the power supply to the controller through the terminals R.

**IMPORTANT:** It is only allowed to connect an electrical heater of 230V/1ph/50 Hz and 1500 W maximum power.









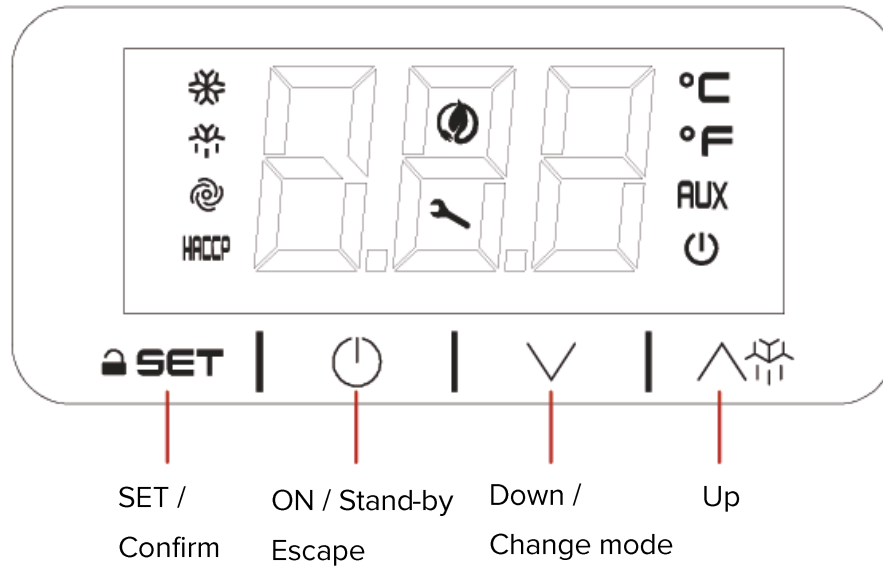



## 10. COMMISSIONING. CONTROLLER.

### 10.1. User interface description





Symbol	Meaning when it lights
	Compressor switched on
	Defrost active. Not used.
	Fan switched on. Not used.
	Alarm active
	Compressor working hours exceeded
	Unit in °C
	Unit in °F
	Electric heater switched on
	Stand by

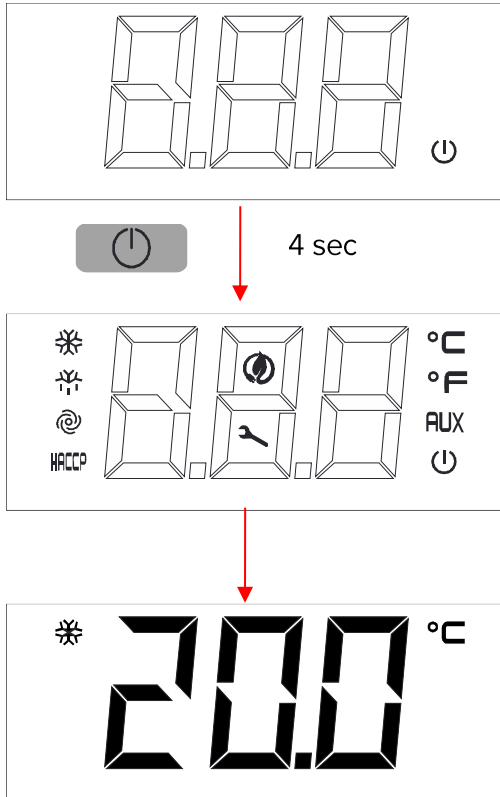

## 10.2. Installation - Switching on

After full installation of the water heater (power and water pipes connected) and after the water heater tank is full of water, power can be turn ON.





1. After filling the tank of water, connect the mains plug to the mains supply.  
The screen will show the  symbol.

2. Hold the  key for 4 seconds.  
The display will show the icons.

3. The screen will show the water temperature.

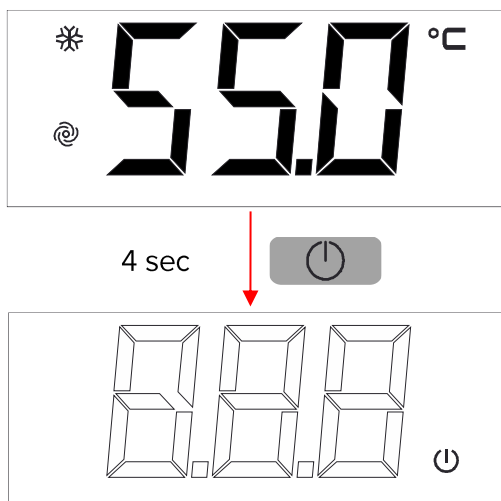
## 10.3. Switching OFF



- To switch off the system, hold the  key for 4 seconds.



#### 10.4. Unlocking the keypad

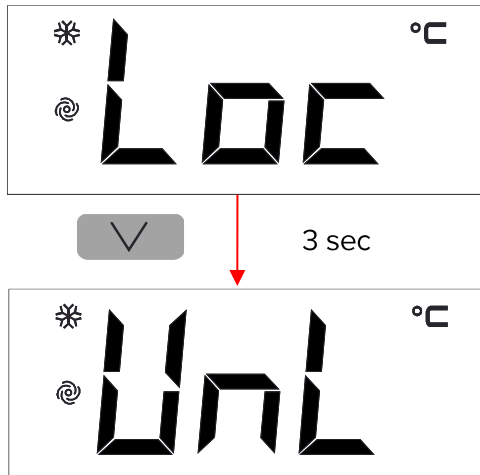

When 30 have elapsed without the keys being pressed, the display will show the " LOC" label and the keypad will lock automatically.

Touch any key until the screen shows UnL, to unlock the keypad.

#### 10.5. Displaying the operating mode

At first initial power ON, the product goes, by default, in Eco mode. By touching one time the  key, the controller will show the mode in operation in this moment.

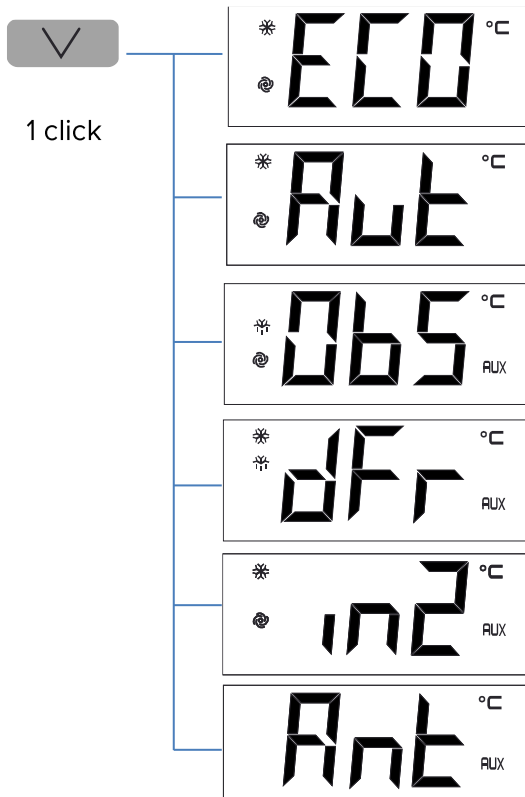

**ECO Mode:** Heating only by heat pump technology

**Auto Mode:** Heating by heat pump and electric heater only if the water temperature falls

**OverBoost Mode:** Simultaneously heating by heat pump and electrical heater to achieve the

**Defrost:** Defrost cycle active

**Photovoltaics/ Timer:** Automatic working due to the existence of surplus energy from PV installation or Off-Peak Rate



**Antilegionella:** Automatic disinfection by thermal shock



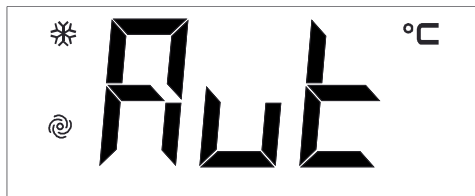
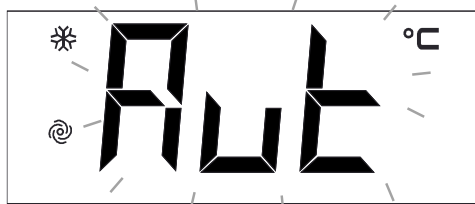

### 10.6. Changing operating mode

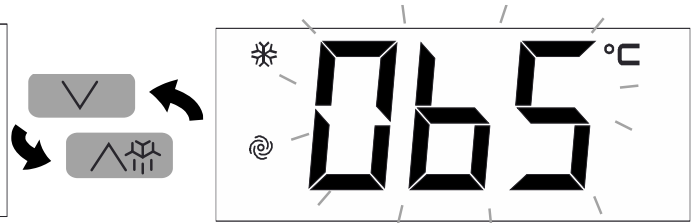

To change the operating mode, touch the  key for 4 seconds.

The screen will show blinking the selectable operating modes. Use the  and  keys to select the operating mode.



Touch  to confirm or  to cancel.

The screen will show again the water temperature.



## 10.7. ECO Mode

ECO mode: Maximum savings. The system heats water only by heat pump technology.

This is the factory default mode.

### Setting the ECO temperature setpoint

The water temperature set point in ECO mode can be changed with the **SP1** parameter.



1 click

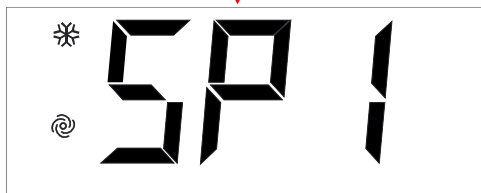

1 click



1 click



Touch key and select SP1. Touch to confirm.

The display will show the programmed temperature.

Touch or to select the desired temperature.

Touch to confirm or to cancel.



### 10.8. AUTO Mode (ONLY IN COMBINATION WITH ELECTRICAL HEATER)

It maintains a steady temperature by the heat pump and only use the electrical heater if the temperature falls drastically.

#### Setting the AUTO temperature setpoint

The water temperature set point in AUTO mode can be changed with the **SP2** parameter.



1 click



1 click



1 click



Touch key and select SP2. Touch to confirm.

The display will show the programmed temperature

Touch or to select the desired temperature

Touch to confirm or to cancel

This mode only works properly if the installer connects the electrical heater to be controlled by the Ecoflex TD.



### 10.9. OVERBOOST Mode (ONLY IN COMBINATION WITH ELECTRICAL HEATER)

Select this mode to achieve a fast heating by using simultaneously heat pump and electric heater.

*This mode works as a rapid heating. Once the setpoint temperature is reached, the system returns to the initial mode.*

- If Overboost mode is switched on when the system Works from **ECO mode**: The system heats the water up to **SP1**, and then returns to ECO again
- If Overboost mode is switched on when the system Works from **Auto mode**: The system heats the water up to **SP2**, and then returns to Auto again

When Overboost mode is active, the display automatically changes showing the water temperature and Obs.

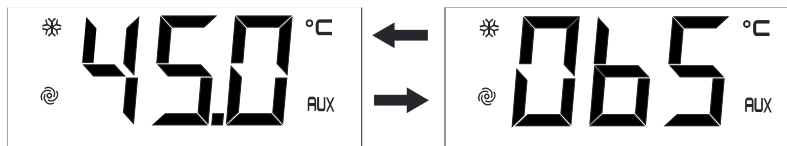

#### Cancelling the Overboost

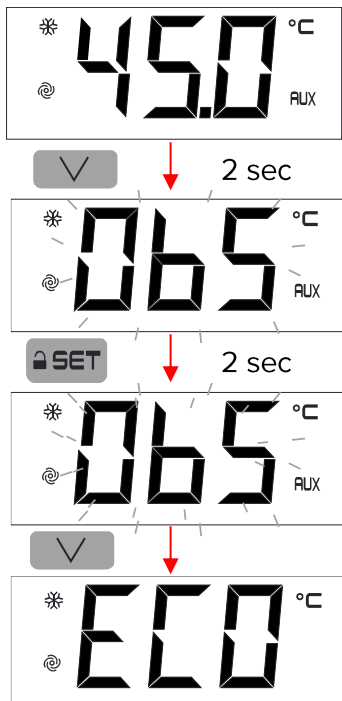

Touch  for 2 seconds, **Obs** will blink on the screen

Touch  for 2 seconds again, **Obs** will blink faster

Touch  and the mode will be changed for the initial mode.



Parameter SP3 allows to set the minimum temperature that Overboost can be activated.

To change it value, follow the procedure:

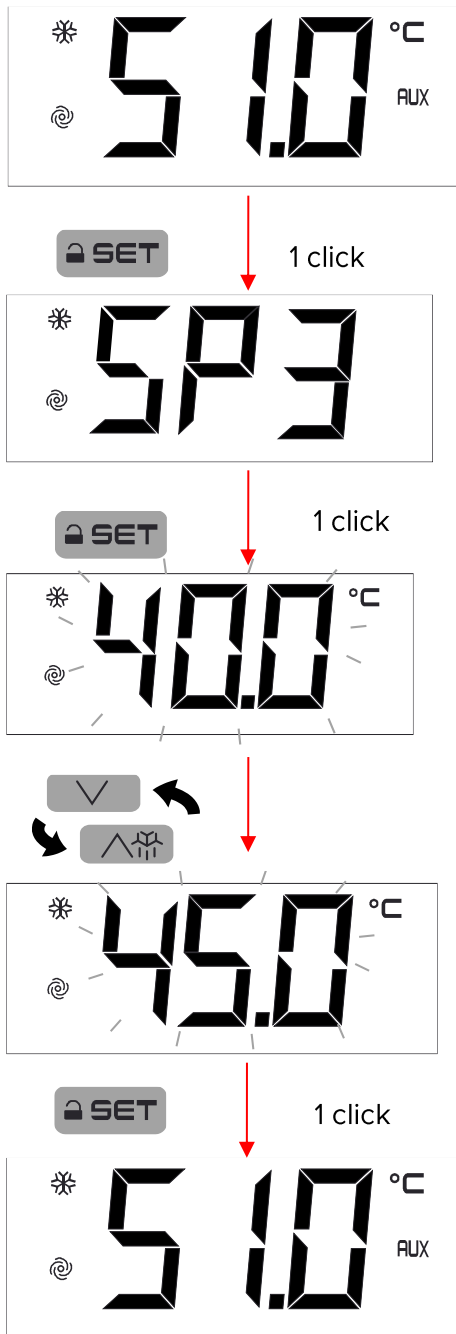

Touch **SET** and select with **∇** and **⏏** SP3. Touch **SET** to confirm.

The display will show the programmed temperature.

Touch **∇** or **⏏** to select the desired temperature

Touch **SET** to confirm or **⏻** to cancel

This mode only works properly if the installer connects the electrical heater to be controlled by the Ecoflex TD.





### 10.10. Photovoltaic input

Working on this mode, the system automatically heats the water due to electric energy surplus or by Off Peak rate.

**The parameters of this mode can only be changed by the Installer's Menu.**

**Contact with the technician for more information.**

The system can be combined with and Photovoltaic Inverter to take advantage of the surplus energy generated by the panels, by forcing the system working and storing this energy in useful hot water.

The system has in the electric boar two terminals to connect a **zero-voltage** contact.



When the contact is closed, the system automatically changes to Photovoltaic mode and the heat pump and electric heater work to achieve the programmed temperature. When the contact is opened, the system returns to the previous mode.

This contact can be also used for Off Peak Rates. To do it, connect into the contact a timer with a **zero-voltage** output.

### 10.11. Displaying/deleting compressor functioning hours

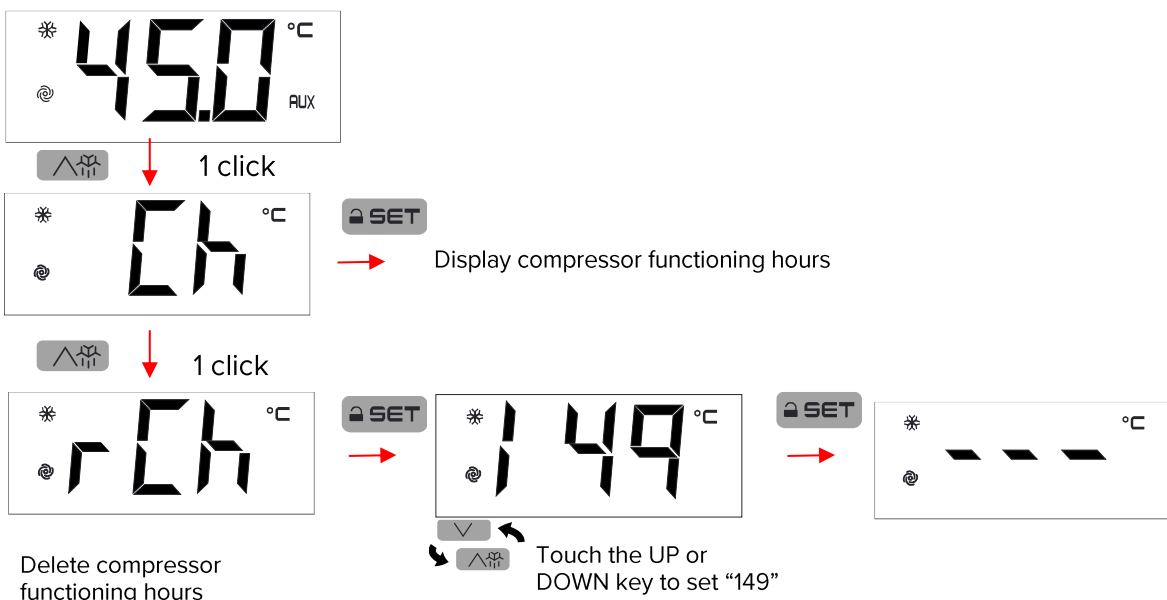



### 10.12. Antilegionella

The anti-legionella feature reduces the risk of development of bacteria in the tank.

The system performs a thermal shock disinfection to avoid any risk conditions that might cause the development of bacteria. The disinfection is made automatically once a week, reaching a temperature of 62 °C.

Anti-legionella can be disabled or enabled in the installer menu.

### 10.13. Alarms

<b>Alarms</b>	<b>Meaning</b>
<b>Pr1</b>	Water temperature probe alarm. Check the temperature probe integrity and the electrical connection
<b>Pr2</b>	Water temperature probe alarm. Check the temperature probe integrity and the electrical connection
<b>Pr3</b>	Evaporator temperature probe alarm. Check the temperature probe integrity and the electrical connection
<b>AL</b>	Low temperature alarm
<b>AH</b>	High temperature alarm
<b>LHP</b>	Low pressure switch alarm / Device blocked Switch the device off and on
<b>HP</b>	High pressure switch alarm Switch the device off and on
<b>FiL</b>	Compressor maintenance alarm By touching any key, you delete the compressor functioning hours
<b>UtL</b>	Evaporator failure alarm Switch the device off and on



## 11. WARRANTY CONDITIONS.

### WARRANTY PERIOD

Component	Warranty period
Electrical, electronic, and mechanical removable components	2 years
Evaporator panel	5 years

### WARRANTY CONDITIONS

The warranty exclusively covers productions faults of the product, excluding any liability for any material damage or injury that results directly or indirectly from the use of this product.

The warranty takes effect from the moment that the system is installed, perfectly justified via the commissioning file correctly completed and sent to the factory within 2 months, or in absence of this justification, the date that shall be take into consideration is the invoice date.

The installer or distributor of the product is the solely responsible for compliance with the installation rules given by the manufacturer.

Failures or incidences due to the following reasons are excluded from the warranty:

- Handling or repair the product by unauthorised personnel.
- Damage caused by impact or fall during handling the product after it leaves the factory.
- Location of the product at any place subject to high temperature, humidity, inclemency, frost, aggressive environment...
- Fault caused by an erroneous installation, which makes the product work out of its design conditions.
- Faults caused by not having installed the supplied security group or incorrect installation thereof.
- Overvoltage power supply (grid, beam...)
- Faulty electrical connection, insufficient wire section, non-compliance with electrical schemes...
- Use water within any of the following criteria:
  - o Calcium carbonate (CaCO<sub>3</sub>) content > 200 mg/L
  - o Soluble salts content higher than 500 mg/L
  - o Alkalinity greater than 150 mg/L (ppm)
  - o Water pH lower than 6 or higher than 9, measured at 20 °C
  - o Chloride content > 500 mg/L
- Fault due to galvanic corrosion result from direct connection of copper pipes without electrolytic sleeve
- Installation of the product in a manner not in accordance with the operating instructions
- Damages result from problems that could not be detectable due to the location of the system (hardly accessible place) and that could have been avoided by a prompt reparation of the product.
- Switch on the heating system without filling the tank (dry heating).
- Any modification of the product without prior agreement with the manufacturer or use spare parts non-authorized or non-supplied by the manufacturer.

Based on these considerations, the warranty comprises in replacing the faulty component to the Installer or Distributor. Transport cost, labour or any compensation are excluded from the warranty.

The fault in single components never comprises the replacing of the product. The installer or distributor is responsible of the changing or reparation of the defective part.

The warranty of the replaced spare part has the same vigour as the product, shall not entail hence the warranty period to be extended or a new warranty period to commence.



CLIMER TECHNOLOGY S.L.L.

*This company reserves the right to modify the information contained herein without prior notice.*